

# SWI-RC



Pacific Accessory Corporation

## Universal Steering Wheel Control Interface

For Alpine, JVC, Clarion, Kenwood,  
Pioneer, Sony, Valor, OEM, Boyo,  
Dual, Visteon, Advent & Blaupunkt  
Steering Remote Ready Radios

# Installation Instructions

### Before You Start



#### A. Is this product compatible with the vehicle?

- Please visit <http://www.pac-audio.com/swixprogramming/swixprogramming.asp> for the most current list of compatible vehicles.



#### B. Prepare for the installation.

- If possible, install the SWI-RC while you are installing the new head unit. Keep in mind you may need to plug in the factory stereo to locate certain wires; therefore do not complete the head unit installation until the SWI-RC is working properly.
- Plan a general installation location for both the SWI-RC plug and the control body. Keep in mind that the supplied wire harness is **two feet long**, and the 1/8" plug harness is **three feet long**.
- Use a multimeter or approved measuring device for checking vehicle circuits.

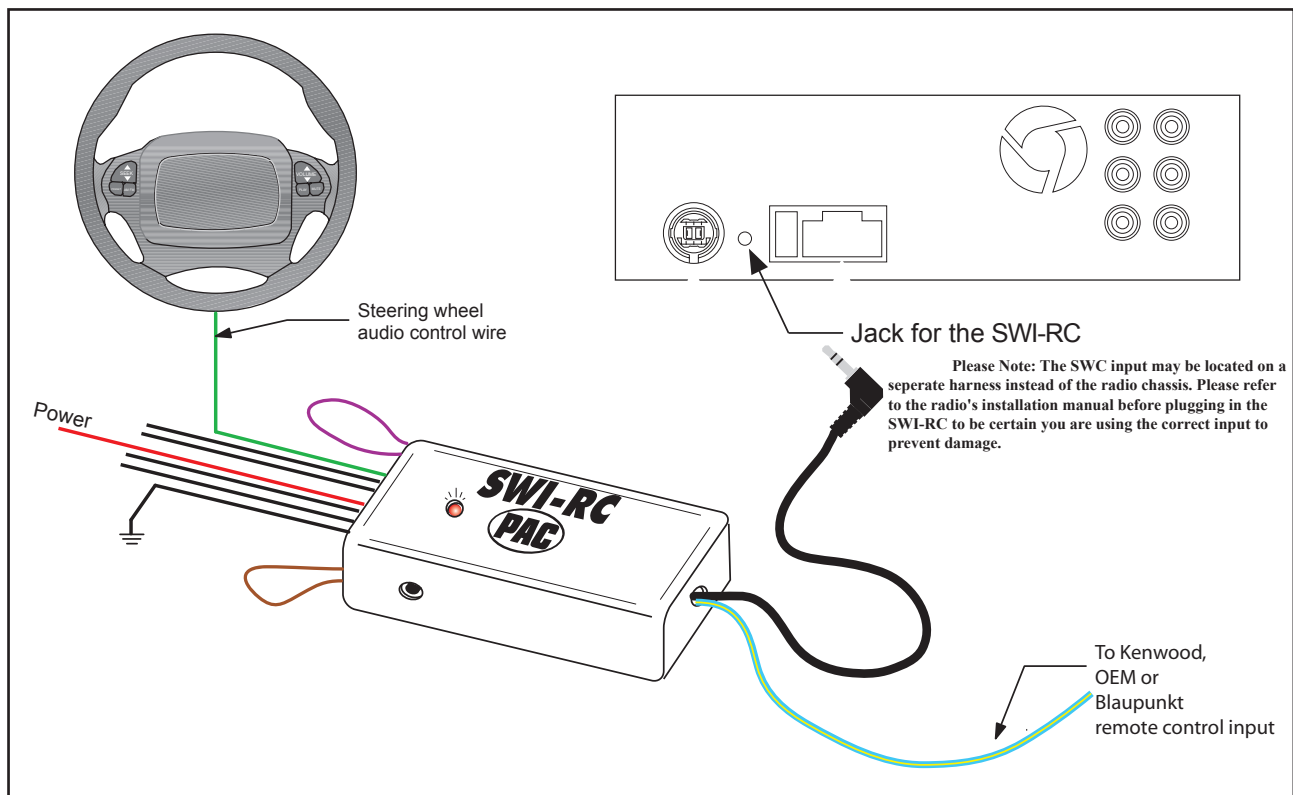

For Alpine, Clarion, JVC, Pioneer, Sony or Valor radios, connect the SWI-RC 1/8" plug into the radio's Steering Wheel input jack on back of radio or wire harness. For Kenwood or OEM radios, connect the blue/yel wire to the remote Input wire (blue/yel or yel/blu for Kenwood, gray for OEM) of radio.

Blaupunkt radios with optional wireless remote inputs are supported by the SWI-RC, however we do not supply any connectors or support for Blaupunkt. It is up to the consumer or installer to supply this connector. Use vehicle Connector Chart and use VW connector as reference. Connect the SWI-RC's blue/yel wire to pin #11 of VW connector. The connector you obtain may come with two of three pieces, however the connector (usually green) should show pin #11 on it.

## Step 1 - Wiring

Note: Only 3 wires from the SWI-RC will be used during installation. GM vehicles programmed for version #4, will use 4 wires.

### Step A.

Connect the BLACK wire to ground (-).

**Verification:** Wire or location registers a constant (-) when probed.

### Step B.

Connect the RED wire to switched +12V.

**Verification:** Wire registers +12V when the ignition key is turned to the ACC or ON positions.

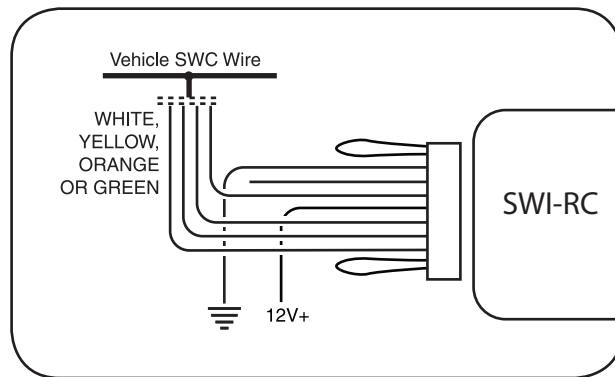

### Step C.

Connect the appropriate interface control input wire (WHITE, YELLOW, ORANGE or GREEN) to vehicle. please refer to the included chart or visit:

[www.pac-audio.com/swixprogramming/swixprogramming.asp](http://www.pac-audio.com/swixprogramming/swixprogramming.asp)

### Step D.

If indicated, cut the necessary loop and add the proper resistor as indicated in the connection chart or on the website.

**NOTE: Using T-Taps is NOT recommended. It is VERY important that ALL connections be solid & secure. Soldering or crimp connects are best and will provide reliable operation.**

## Step 2 - Programming the Version #

### Step A.

Refer to **The Vehicle Application Guide** or [www.pac-audio.com/swixprogramming/swixprogramming.asp](http://www.pac-audio.com/swixprogramming/swixprogramming.asp) for the proper version number. Refer to the programming chart on page 4 for the proper radio select switch setting. Fill in the information below for quick reference. Please note that it is very important to set the radio select switch before turning on the ignition beginning programming.

Vehicle Version Number: \_\_\_\_\_ Radio Select Switch: \_\_\_\_\_



Radio Select Switch located on the side of SWI-RC interface

### Step B.

Press and hold programming/mode button on SWI-RC. Turn the vehicle ignition to the ON position while still holding the button in.

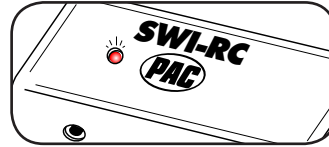
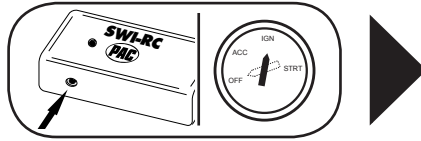

The LED on the SWI-RC will light.

### Step C.

Release the programming/mode button.

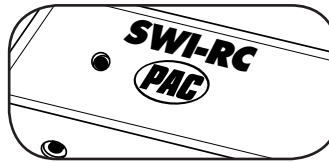
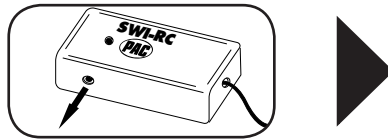

The LED will turn off, indicating memory is cleared.

### Step D.

Press and release the programming/mode button the same number of times as the desired version number.

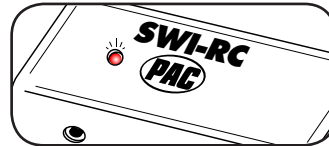
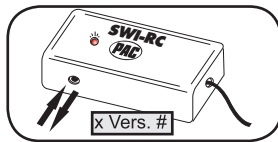

The LED will flash each time the button is pressed and released.

### Step E.

**WAIT 3 seconds**, the LED will flash the same amount of times as set version number.

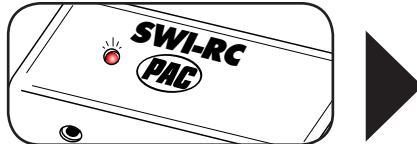

### Step F.

Turn vehicle ignition to OFF position. Vehicle programming sequence is complete.

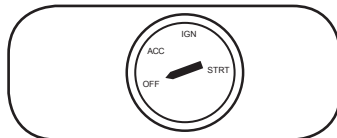

## Step 3 - Programming the SWI to Learn Steering Wheel Control Functions

The SWI-RC must be programmed in the specific order shown in the chart below. If you come across a command in the chart that your steering wheel does not have, or you do not want to program, press the Program Button on the side of the SWI interface. The LED will flash once rapidly and then stay on confirming that you have successfully skipped that command and are ready for the next button.

Switch Position	1	2	3	4	5	6	7	7	8
Radio	Alpine	JVC	Kenwood	Clarion	Valor	OEM	Advent, Boyo, Dual, Visteon, Sony	Pioneer	Blaupunkt
1	Volume +	Volume +	Volume +	Volume +	Volume +	Volume +	Volume +	Volume +	Volume +
2	Volume -	Volume -	Volume -	Volume -	Volume -	Volume -	Volume -	Volume -	Volume -
3	Mute	Mute	Mute	Mute	Mute	Mute	Mute	Mute	Mute
4	Preset +	Source	Source	Source	Source	Source	Preset +	Preset +	Source
5	Preset -	Track +	Play	Search +	Track +	Next	Preset -	Preset -	Track +
6	Source	Track -	Track +	Search -	Track -	Previous	Source	Source	Track -
7	Track +	Band/Disc +	Track -	Band	Up Cursor	Play/Ok	Track +	Track +	Disc +
8	Track -	Preset/Disc -	Disc/FM +		Down Cursor	Band	Track -	Track -	Disc -
9	Power	Select	Disc/AM -		Ok	Up Cursor	Band	Band	Ok
10	Enter/Play	Attenuation	Answer			Down Cursor		Phone Menu	
11	Band/Program	Phone Receive				BT Answer		Answer Call	
12		Phone Reject				BT Hangup		End Call	
13		Voice Dial						Voice Activation	
14		Power							

### Step A.

Turn the vehicle ignition to the ON position.

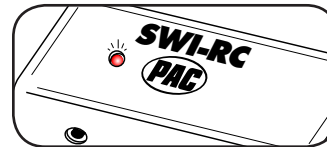
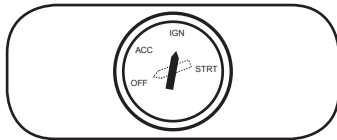

LED will flash to indicate set vehicle version number.

### Step B.

Press and hold programming/mode button on SWI-RC.

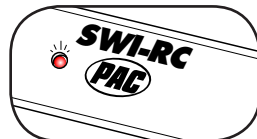
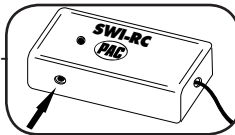

LED will light.

### Step C.

Release programming/mode button.

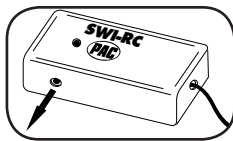

LED will stay lit for 7 seconds.



If you programmed the module for version 4 please refer to Appendix A

### Step D.

Within 7 seconds, press and hold for 5 seconds the button that is to be learned on the steering wheel. **Please note if using in conjunction with the OS-4 or MS-FRD1 the Source, Media or Speak buttons cannot be held for more than 1.5 seconds.**

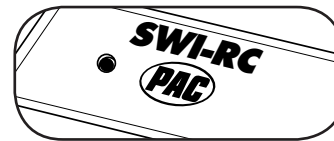
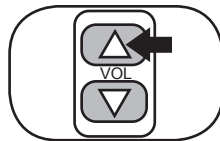

The LED will turn off during this process.

### Step E.

Release the button.

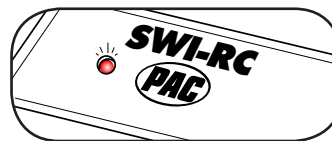
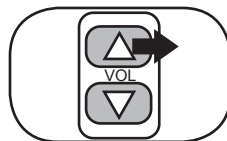

The LED will turn on back on.

### Step F.

If you need to program more buttons, <sup>4</sup>repeat steps D & E for each additional audio function on the steering wheel.

Program remaining buttons



### Programming the SWI-RC to Control the Head Unit (cont.)

**Step G.**  
After all buttons are programmed

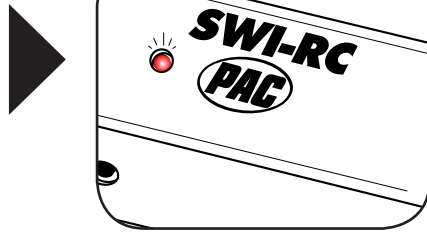

Once programming is completed, **wait 7 seconds.** The LED will flash three times indicating end of programming. The Interface will then flash the vehicle version number it was programmed for.

### Testing the SWI-RC

**A.** When testing the audio controls, the left LED on the SWI-RC will flash indicating it is sending a command. If any function does not work, repeat the programming instructions (starting from Step 11) or refer to **Troubleshooting Guide.**

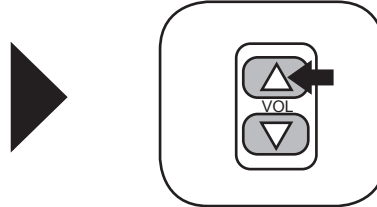

### Appendix A.

If you programmed the interface for version #4, proceed with the following steps. If you did not program the interface for version #4, please disregard.

**Step A.**  
Turn the vehicle ignition to the ON position.

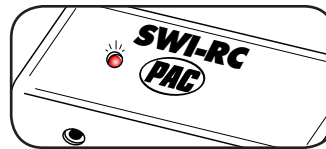
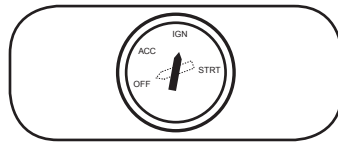

LED will flash 4 times to indicate set version number.

**Step B.**  
Press and hold programming/mode button on SWI-RC.

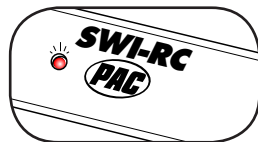
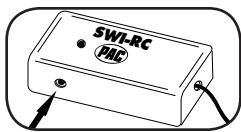

LED will light.

**Step C.**  
Release programming/mode button.

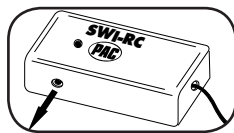

LED will turn off

**Step D.**  
Press and hold the TEMP UP button on the steering wheel control.

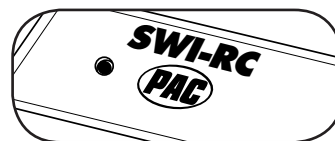
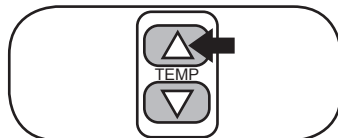

LED will turn off.

**Step E.**  
Release the TEMP UP button.

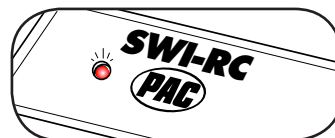
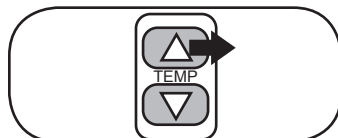

LED will turn on. The function is programmed.

**Step F.**

Repeat Steps D and E, using the TEMP DOWN Button.

**Step G.**

*If the vehicle is equipped with FAN UP and FAN DOWN buttons:*

Repeat Steps D and E for these buttons as well.

**Step H.**

*If the vehicle is NOT equipped with FAN UP and FAN DOWN buttons:*

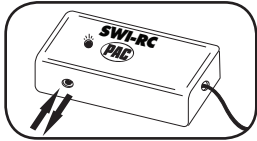

Press and release the programming/ mode button on the SWI-RC.

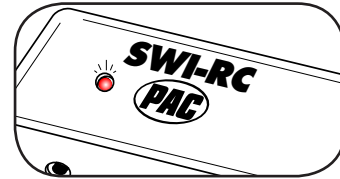

In either case, the LED will flash once and stay on.

**Step I.**

Within 7 seconds, press and hold for 5 seconds the button that is to be learned on the steering wheel.

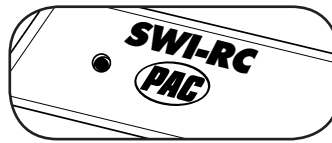
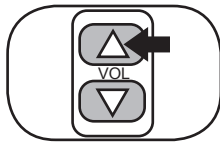

The LED will turn off during this process.

**Step J.**

Release the button.

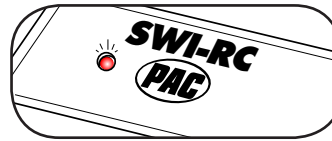
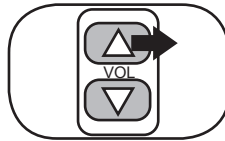

The LED will turn on back on.

**Step K.**

If you need to program more buttons, repeat steps I & J for each additional audio function on the steering wheel.

Program remaining buttons

**Step L.**

After all buttons are programmed

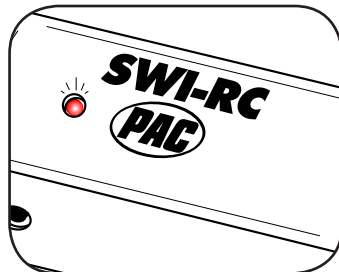

Once programming is completed, **wait 7 seconds**. The LED will flash three times indicating end of programming. The Interface will then flash the version number it was programmed for.

**Testing the SWI-RC**

**A.** When testing the audio controls, the left LED on the SWI-RC will flash indicating it is sending a command. If any function does not work, repeat the programming instructions (starting from Step 11) or refer to **Troubleshooting Guide**.

**B.** (For Version #4 only) Test each Heater function of the steering wheel controls. The TEMP and FAN should work properly.

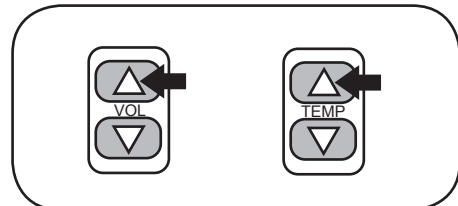

Vehicle Make	Year/Model	Description
Audi	2002-2008 A4/S4 2002-2005 A6/S6	The SWI-CAN must also be used
BMW	All	All with 5-Volt SWC data wire at the steering column All with factory activated cellular phones
Mercedes	2003-2004 C230 2003-2004 CLK 2003-2004 CLK 320	The SWI-CAN must also be used
	200-2002 CLK 2007 CLK 350 200-2007 E 2008 GL 2001-2003 S 2006 SLK	The SWI-CAN2 must also be used
Mitsubishi	2006-2007 Raider	The SWI-CAN2 must also be used
Chrysler, Dodge, Jeep	2004+ Durango All 2005+ Vehicles	The SWI-CAN or SWI-CAN2 must also be used (unless you are using the SWI-RC in conjunction with the C2R-CHY4)
Porsche	Cayenne	The SWI-CAN must also be used
Toyota	Sienna	All before 2001
Volkswagen	All	The SWI-CAN must also be used in all models with double DIN head units
Volvo	All	All

Appendix C: Resistor Kit

Some vehicles have a separate wire for each of the steering wheel buttons. Use this resistor kit for the steering wheel push buttons that do not already have a resistor network connected to them. Examples are Nissan and Harley Davidson motorcycles.

Connect a resistor to each side of a push button and connect the other ends of the resistor all together. Connect the SWI-RC's white wire to these resistors. On the Harley Davidson, one button can be connected directly to the SWI-RC.

- 47 = yel, vio, blk
- 100 = brn, blk, brn
- 150 = brn, grn, brn
- 560 = grn, blu, brn
- 1000 = brn, blk, red
- 1500 = brn, grn, red
- 3900 = org, wht, red
- 5100 = grn, brn, red

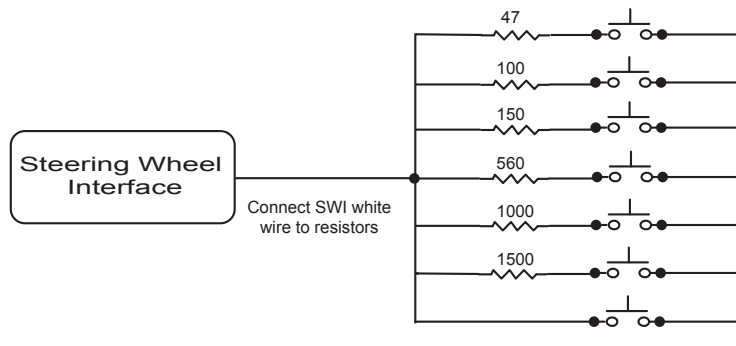

By putting two or more resistor in series, you can come up with additional values. Ex.  $150 + 1000 + 1500 = 2650$  ohms.

Please visit <http://www.pac-audio.com/swixprogramming/swixprogramming.asp> for the most up to date vehicle instructions.

## Troubleshooting Guide

### **My Vehicle is not listed in the Identification and Connection Chart:**

- Please visit <http://www.pac-audio.com/swixprogramming/swixprogramming.asp> for the most up to date listing of compatible vehicles.

### **I cannot program the INTERFACE version number:**

- Is the radio selection switch in position "0"? If so refer to page 5 and select a radio position before attempting to program a version number.

### **No power / won't go into programming mode:**

- Check **Red** wire connection and fuse. Make sure INTERFACE is connected to switched +12 volts, not constant +12 volts.
- Make sure vehicle ignition is on.

### **The INTERFACE controls the stereo immediately without pressing any buttons on the steering wheel**

- During programming, press the buttons on the steering wheel firmly UNTIL the left LED turns off. Releasing the button too early will cause the INTERFACE to send out a signal even when no buttons are pressed.
- Ensure that the brown loop is not cut unless instructed

### **The radio changes when the key is off (RAP mode pertaining to GM vehicles) or does not work when the car/truck is running:**

- The INTERFACE's Red accessory wire needs to be connected to the same circuit as the radio. If you are using a radio replacement interface that does not supply BATTERY voltage as the ACC. circuit, a relay need to be installed as follows:
- Terminal 86 to supplied ACC wire, Terminal 85 to Gnd Terminal 30 to the INTERFACE Red wire and Terminal 87 to BATTERY.

### **When programming the SWC buttons, it takes 5 seconds for the light to go out and it never comes back on:**

- Do the connection instructions say to connect another vehicle wire to ACC voltage or chassis ground? If so, test the circuit with a Digital Multi Meter (the factory radio must be plugged in) and verify that the factory radio is providing the same output.

### **The INTERFACE controls the radio whenever the steering wheel is turned (mostly late 80's early 90's Honda/Acura):**

- Program the INTERFACE for version #12.

### **Working on a new or unlisted vehicle?**

We are always looking for new vehicle information. If you've successfully completed the installation on a vehicle with steering wheel controls, and the vehicle is not listed in these instructions or on our Website, contact us at [techsupport@pac-audio.com](mailto:techsupport@pac-audio.com) so that we may add the information to the instructions.

### **Pacific Accessory Corporation**

Santa Ana, CA 92705

[techsupport@pac-audio.com](mailto:techsupport@pac-audio.com) • [www.pac-audio.com](http://www.pac-audio.com)

Copyright 2010 Pacific Accessory Corporation. Content subject to change without notice.